

HSF

NOTES:

Current Rating:8A
 Voltage Rating:300V
 Contact Resistance:8milliohm Max
 Withstand Voltage:AC2000V
 Insulation Resistance:1000Megohm Min
 Operation Temperature:-40°C to +105°C

Housing Material:PA66+30%GF(UL94V-0) 
 Contact Material:Brass

Recommended P.C.B Layout (Top Side)
 (PCB BOARD TOLERANCE±0.05)

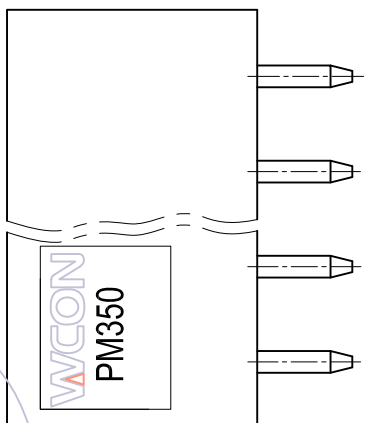
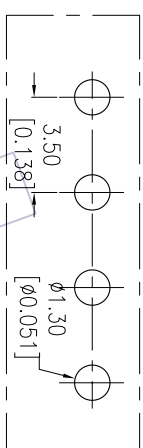

Ordering Information:



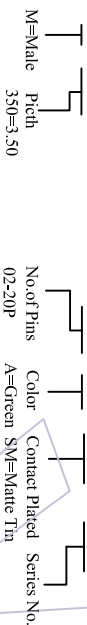

P M 350 - 1 S XX A SM 1

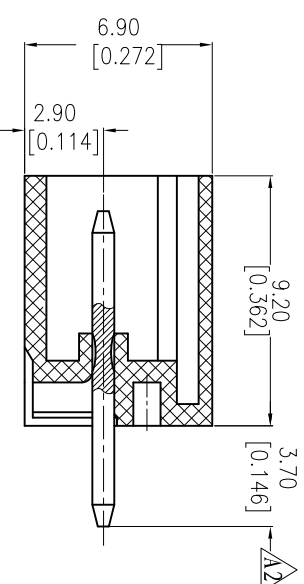
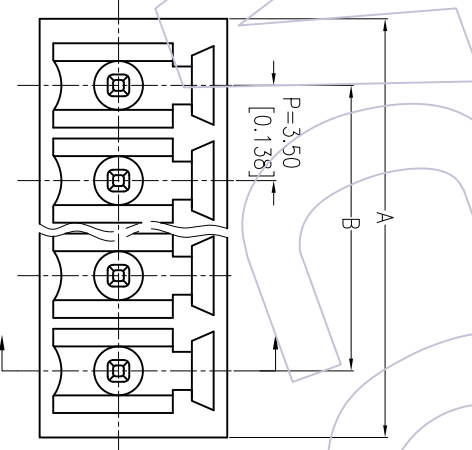

11P	39.90 ±0.30	35.00 ±0.30			
10P	36.40 ±0.30	31.50 ±0.30	20P	71.40 ±0.40	66.50 ±0.40
9P	32.90 ±0.30	28.00 ±0.30	19P	67.90 ±0.40	63.00 ±0.40
8P	29.40 ±0.20	24.50 ±0.20	18P	64.40 ±0.40	59.50 ±0.40
7P	25.90 ±0.20	21.00 ±0.20	17P	60.90 ±0.40	56.00 ±0.40
6P	22.40 ±0.20	17.50 ±0.20	16P	57.40 ±0.40	52.50 ±0.40
5P	18.90 ±0.20	14.00 ±0.20	15P	53.90 ±0.40	49.00 ±0.40
4P	15.40 ±0.20	10.50 ±0.20	14P	50.40 ±0.30	45.50 ±0.30
3P	11.90 ±0.20	7.00 ±0.20	13P	46.90 ±0.30	42.00 ±0.30
2P	8.40 ±0.20	3.50 ±0.10	12P	43.40 ±0.30	38.50 ±0.30
PIN	A	B	PIN	A	B

ITEM	Pitch	Mating
Standard	3.50	PC350
Alternate		



A3	2013/06/05	Modify The Housing Material		OPERATION	±0.40	DRAW	Tsingn	DATE	2013/06/05	SCALE	FIT	PART NO.	PM350-1SXXASMI 	 Http: www.wcon.com WCON-Dongguan Tel: +86 769 85358920 WCON-Kunshan Tel: +86 512 57468408 WCON-Fax: +86 512 57468408 WCON-E-mail: sales@wcon.com
A2	2013/04/24	Modify The Dimension 3.50 To 3.70		XX	±0.25	CHECK		DATE		UNIT	mm	TITLE:	3.50mm Pitch Male	
A1	2012/05/09	MODIFY PR350-00-XX-A-SM → PM350-1SXXASMI		X.XXX	±0.15	APPROVE		DATE		SIZE	inch	Customer NO.	Pluggable Terminal Blocks	
A0	2011/06/07	NEW		Angle	± 3'	PROJ.				SHEET	1/1			
REV	DATE	MODIFICATION DESCRIPTION	CHANGE	DIM	TOL									

1 2 3 4 5 6 7 8 9 10